



# **SOLAR** *motion-activated* **SECURITY LIGHT**

Model #: 40225, 40226

## **ASSEMBLY & OPERATING INSTRUCTIONS**

**Solar Motion-Activated Security Light - 80 LED Lights**

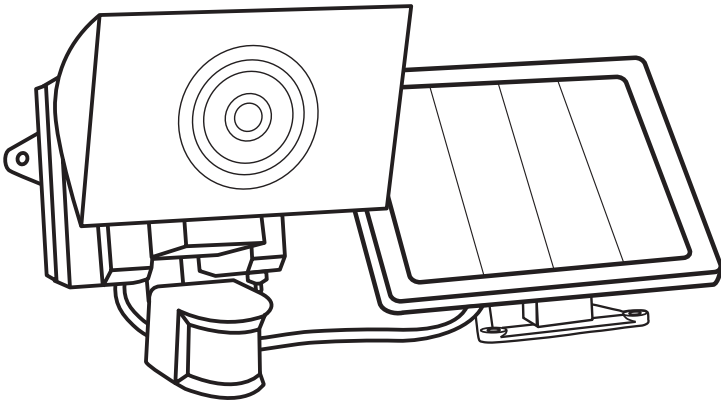

**IMPORTANT: READ ALL INSTRUCTIONS CAREFULLY BEFORE USE**

### **ABOUT YOUR SOLAR SECURITY LIGHT**

During the day, the solar panel included with this MAXSA Solar Security Light converts sunlight into electricity, recharging the pre-installed battery. Using this stored energy, the 80 LED lights turn on automatically at night when motion is detected. This MAXSA Solar Security Light has an adjustable TIME dial that allows light duration of up to 60 seconds. When the battery is fully charged, this Solar Security Light can light up for up to 2.5 hours, which is equivalent to 150 one-minute cycles when the TIME dial is set to the maximum (+) position.

The battery included in this unit is a sealed lead-acid 6V, 4Ah rechargeable battery and will need to be replaced when the charging ability is decreased. The battery should last for approximately 3 years before it will need to be replaced.

Carefully remove and identify all the parts from their protective packaging and lay them out in front of you.

## INCLUDED PARTS:

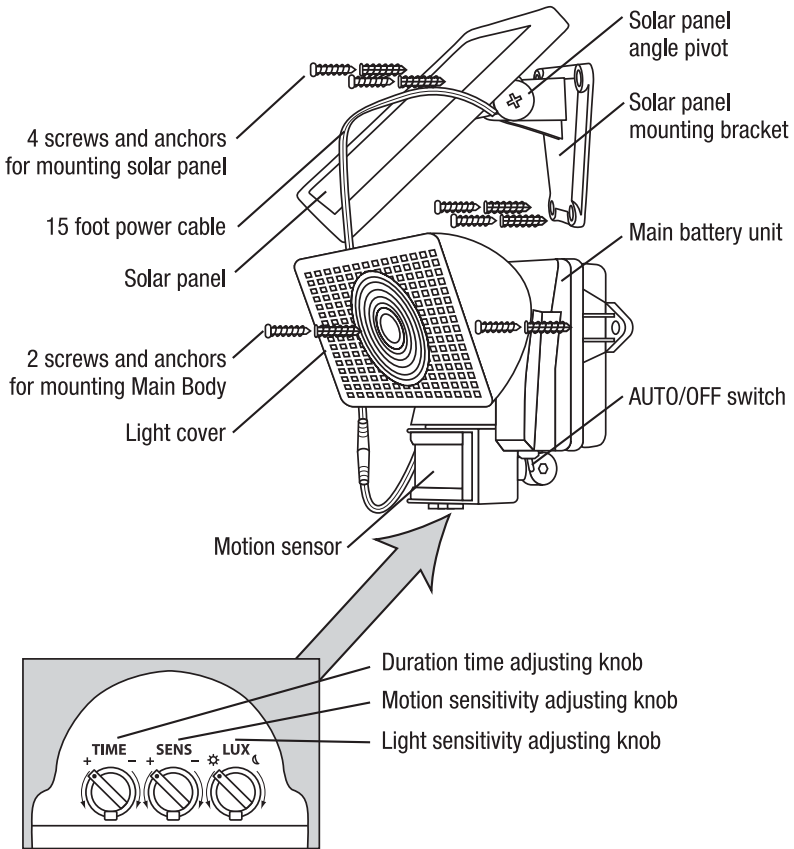

Once you have identified all parts, connect the solar panel to your Solar Security Light by plugging the 15 foot cord into the cord attached to the front of the Solar Security Light. Turn and twist the cords while pressing firmly together until they are attached tightly.

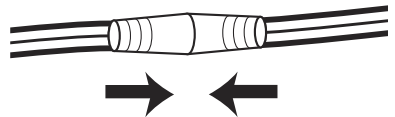

Adjustment dials are located on the underside of the motion sensor. Move the motion sensor to allow for easier access to the controls. Move sensor back into position upon completion.

## CHOOSING A LOCATION FOR YOUR SOLAR SECURITY LIGHT

This Solar Security Light comes complete with a solar panel attached to a 15 foot power cord. For optimum sun exposure and longer light output, place the solar panel in a position that receives at least 6-8 hours of direct sunlight per day. Placing the solar panel in a shaded location will not allow the battery to charge fully, reducing the number of hours the light will operate per evening. Ensure that the solar panel is not placed near night time light sources such as porch lighting or street lighting.

This Solar Security Light is ideal for areas where electricity is not available — including driveways, carports, garages and entrance doors – for safety and security around your home.

When deciding where to mount the light, keep in mind that the motion sensor has a field of vision of 180° (horizontal) at a distance of 40 feet when the surrounding temperature is 75F. The outside temperature will impact the detection distance.

## HOW TO INSTALL YOUR SOLAR SECURITY LIGHT

1. Mount the Security Light onto a solid surface, using the two (2) wood/sheet metal screws supplied. You may mount the Security Light either vertically or horizontally.
2. Use the four wood/sheet metal screws supplied to mount the solar panel onto a solid surface. You can adjust the angle of the solar panel by gently rotating the solar panel to a different locking position. Remember to face the panel south for direct sunlight exposure.

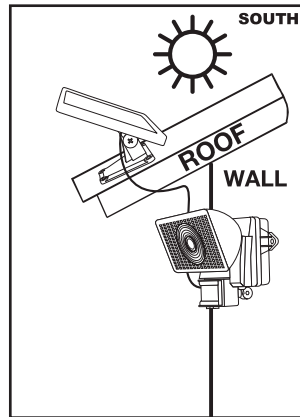
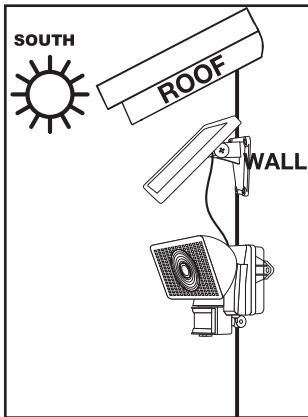

## TOOLS REQUIRED FOR INSTALL

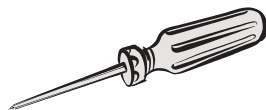

Install simply with just a Phillips-head screwdriver!

## BEFORE FIRST USE OF YOUR SOLAR SECURITY LIGHT

1. Ensure the power switch on the main body of your Security Light is in the OFF position. In this position, the solar panel will charge the battery without activating the unit.
2. Leave the switch in the OFF position for 3 days with the solar panel placed in direct sunlight. This will ensure that the battery in your Solar Security Light has a full charge prior to motion sensor adjustment and normal operation.

## OPERATING YOUR SOLAR SECURITY LIGHT

After the initial 3 day charge of your Solar Security Light, move the switch on the main body to the AUTO position. Your Solar Security Light is now ready for use.

Underneath the motion sensor, there are 3 adjustment dials: TIME/SENS/LUX. The light has been factory preset as follows:

TIME - Set at 30 seconds.

SENS - Set at a 10 - 15 foot range (when the surrounding temperature is 75 F).

LUX - Set for your Security Light to activate at dusk when motion is detected.

If the above settings are not suitable for your application, then these may be adjusted using the steps below.

## TIME PERIOD ADJUSTMENT (TIME)

The time period adjustment control dial sets the duration of the light upon each activation that the Solar Security Light will remain illuminated after the last detected motion. The time period has an adjustable range of 10 seconds to 1 minute.

To decrease the time period, move the dial toward the ( - ) symbol.

To increase the time period, move the dial toward the ( + ) symbol.

Test the time period by triggering the motion sensor and measure the time period the light stays on. Adjust the TIME control until the desired illumination duration is reached.

A shorter TIME setting will conserve battery life. For best results, use the shortest TIME setting for your location as possible.

## MOTION SENSOR ADJUSTMENT (SENS)

The motion sensor on this Solar Security Light is temperature-sensitive. The cooler the temperature, the more sensitive the motion sensor will become. Use the SENS dial to adjust the sensitivity of the motion sensor to compensate for environmental temperature changes. The motion sensor is most sensitive when the SENS dial is turned fully clockwise (+).

To decrease sensitivity, move the dial toward the ( - ) symbol.

To increase sensitivity, move the dial toward the ( + ) symbol.

To test the motion sensitivity, aim the sensor head toward the desired area. Set the TIME dial to minimum ( - ) position and the LUX dial to the bright setting (☀).

Walk slowly around the area of detection, changing your walking pace until the light comes on. If light does not come on, you may need to adjust the angle of the sensor unit. Make adjustments as needed until the desired level of sensitivity is reached. Re-adjust the TIME and SENS dials when complete.

## LIGHT LEVEL ADJUSTMENT (LUX)

The LUX dial controls the natural light level that triggers the Solar Security Light and prevents the light from operating during daylight hours.

Your Solar Security Light comes preset for activation at dusk.

To adjust for activation in a brighter setting, move the dial toward bright (☀).

To adjust for activation in a darker setting, move the dial toward dark (☾).

## REPLACING THE BATTERY

When the charging ability of the batteries decreases, you can replace the battery with a new 6V, 4Ah lead acid battery. Follow the steps below when replacing the battery.

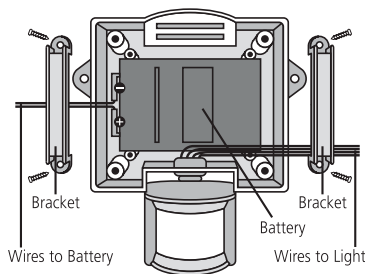

1. First remove the main unit from its mounted surface and unplug the solar panel.
2. Move the power switch on the main body to the OFF position.

3. Remove the four (4) screws on the back of the main unit that hold the halves together.
4. Once the unit is open, carefully remove the two (2) brackets holding the battery in place by unscrewing the four (4) screws as indicated in the diagram above.
5. Carefully unplug the positive and negative cords.
6. Carefully remove the battery from its compartment and replace with a new 6V, 4Ah rechargeable lead acid battery. Ensure that the red cord is re-attached to the red-colored battery terminal. (WARNING: Connecting these in the opposite direction could damage the unit.)
7. Replace the two (2) brackets to hold the battery in place by using the four (4) screws removed in step 4, taking care not to damage any cables.
8. Re-assemble the main unit by screwing the two (2) halves of the main body together securely.
9. Once assembled, mount your Solar Security Light to its original surface location.
10. Repeat the steps in the “Before first time use of your Solar Security Light” section on page 4 to ensure your new battery is fully charged.

**NOTE: Do not dispose of batteries in general household trash or into a fire since the batteries may explode. Consult your local regulations for correct disposal of batteries. The batteries may also be returned to MAXSA Innovations at 8412 Cathedral Forest Dr., Fairfax Station, VA 22039. Do not take apart the batteries since they contain corrosive chemicals.**

## **MAINTENANCE TIPS**

The LED lights in your Solar Security Light will last up to 30,000 hours and should never need replacement.

To keep your Solar Security Light looking new, keep the lens free of dust and deposits by wiping occasionally with a dry cloth or with warm soapy water.

It is important that the solar panel is kept free of dirt and debris at all times. A dirty solar panel will not allow the batteries to be fully charged. This will shorten the life of the battery and may cause the light to malfunction.

## **STORAGE**

If you wish to store your light indoors for more than two or three days, turn the power switch to the OFF position to prevent damage to the batteries. Battery capacity may be reduced during prolonged storage. For optimal performance, we recommend that you do not store your Solar Security Light for prolonged periods of time.

# TROUBLESHOOTING

| PROBLEM   | POSSIBLE SOLUTIONS   |
|---|--|
| <p>Light will not switch on when there is movement in the detection area.</p> | <ul style="list-style-type: none"> <li>• Ensure that the power switch on the main body has been turned to the AUTO position.</li> <li>• Ensure that the motion sensor has been positioned to face oncoming movement.</li> <li>• Ensure that the battery has been fully charged in direct sunlight for 3 sunny days. Refer to the “Before First Use of Your Solar Security Light” section on page 4.</li> <li>• Check to see that the solar panel is facing south so that it receives direct sunlight for most of the day, enabling the battery to fully charge.</li> <li>• Check to see that the LUX control has not been set too far towards (☺). Setting the LUX control too far towards (☺) will cause the Solar Security Light to turn on only in complete darkness.</li> <li>• Check to see that the motion sensor is not near night time light sources such as street lights.</li> </ul> |
| <p>Light switches on during the day.</p>                                      | <ul style="list-style-type: none"> <li>• The LUX control may be set too far towards the (☺) position.</li> <li>• Reposition the motion sensor.</li> </ul>  |
| <p>Light switches on for no apparent reason.</p>                              | <ul style="list-style-type: none"> <li>• The SENS control may be set too far towards the (+) position.</li> <li>• Moving trees, traffic, pets or birds may be getting in the area of detection. This may be unavoidable, however the sensor could be redirected to a height where this is less likely to occur.</li> <li>• If there are reflective objects in the detection area such as windows, water, or white walls, you may need to redirect or possibly reposition the motion sensor.</li> <li>• Test the motion sensor by covering it completely with cardboard and waiting several minutes to make sure it does not detect motion. If the light still switches on, please contact MAXSA for further assistance.</li> </ul>   |
| <p>Light quickly flashes on and off.</p>                                      | <ul style="list-style-type: none"> <li>• Battery charge may be low. Turn the power switch to the OFF position and charge the battery for three (3) sunny days with the solar panel placed in direct sunlight.</li> <li>• Move the LUX control more to the (☺) position.</li> </ul>   |
| <p>Light is not as bright as normal.</p>                                      | <ul style="list-style-type: none"> <li>• Battery charge may be low. Turn the power switch to the OFF position and charge the battery for three (3) sunny days with the solar panel placed in direct sunlight.</li> </ul>   |

## 90 DAY LIMITED WARRANTY

This Solar Motion-Activated Security Light is warranted against faulty material and/or workmanship for a period of 90 days from date of original purchase.

The obligation of the manufacturer, under this warranty, is limited to servicing and replacing defective parts when the unit is returned to MAXSA Innovations, freight pre-paid during the warranty period. To obtain warranty repair, the purchase receipt should be returned with the product.

This warranty becomes void on any unit which has been tampered with, damaged by accident, or damaged otherwise by improper operation.

This guarantee is in addition to any guarantees implied by State or Federal Legislation.

**Please save these instructions for future reference.**

**MADE IN CHINA**



**MAXSA Innovations**  
8412 Cathedral Forest Drive  
Fairfax Station, VA 22039  
Tel: 703-495-0661

**[www.maxsainnovations.com](http://www.maxsainnovations.com)**  
**[info@maxsainnovations.com](mailto:info@maxsainnovations.com)**